

Article number: 12347000140500  
Description: KLEE-coil 347 000 140.500  
M 14 St. steel 1.4305

## Measures

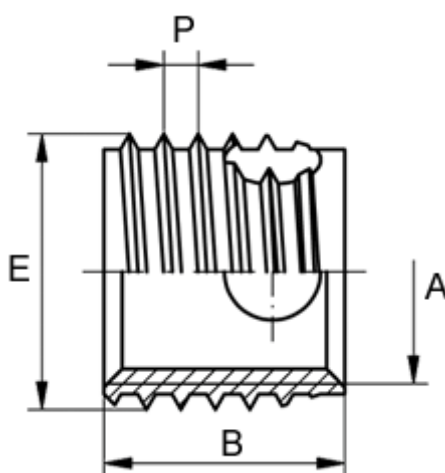

Female thread A	= M14
Length B	= 14
Male thread E	= 16.0
Min hole depth blind hole	= 17
Pre-drilled max	= 15.4
Pre-drilled min	= 15.1
Thread pitch P	= 2.00
Type	= 347 000 140 ...